

100% of our products are made from recycled polymers



Producing high quality composite products, we meet all European standards and regulations (EN124 certificate)



We make a positive environmental impact using recycled polymers, reducing waste and promoting circular practices

 www.sandcore.eu  ah@sandcore.eu  +370 69504141

CABLE CHAMBER

400x400x800

From polymer composite

INCLUDES:

Cover & Frame – 1 pc

Walls – 4 pcs

Bottom – 1 pc



INTERNAL DIMENSIONS, MM

400x400x800

EXTERNAL DIMENSIONS OF COVER, MM

460x460x899

COVER LOADING CAPACITY

B 125

400x400x800

CABLE CHAMBER

From polymer composite
100% recycled materials

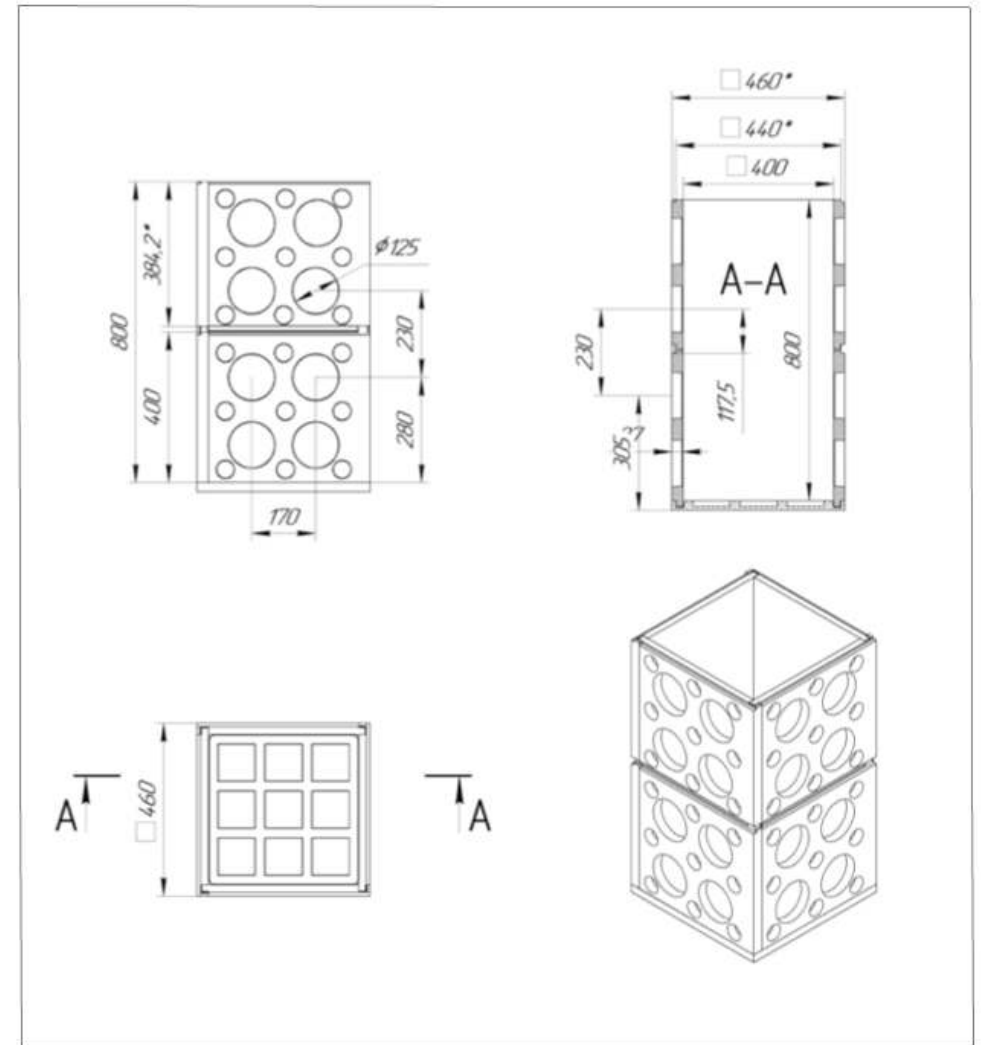
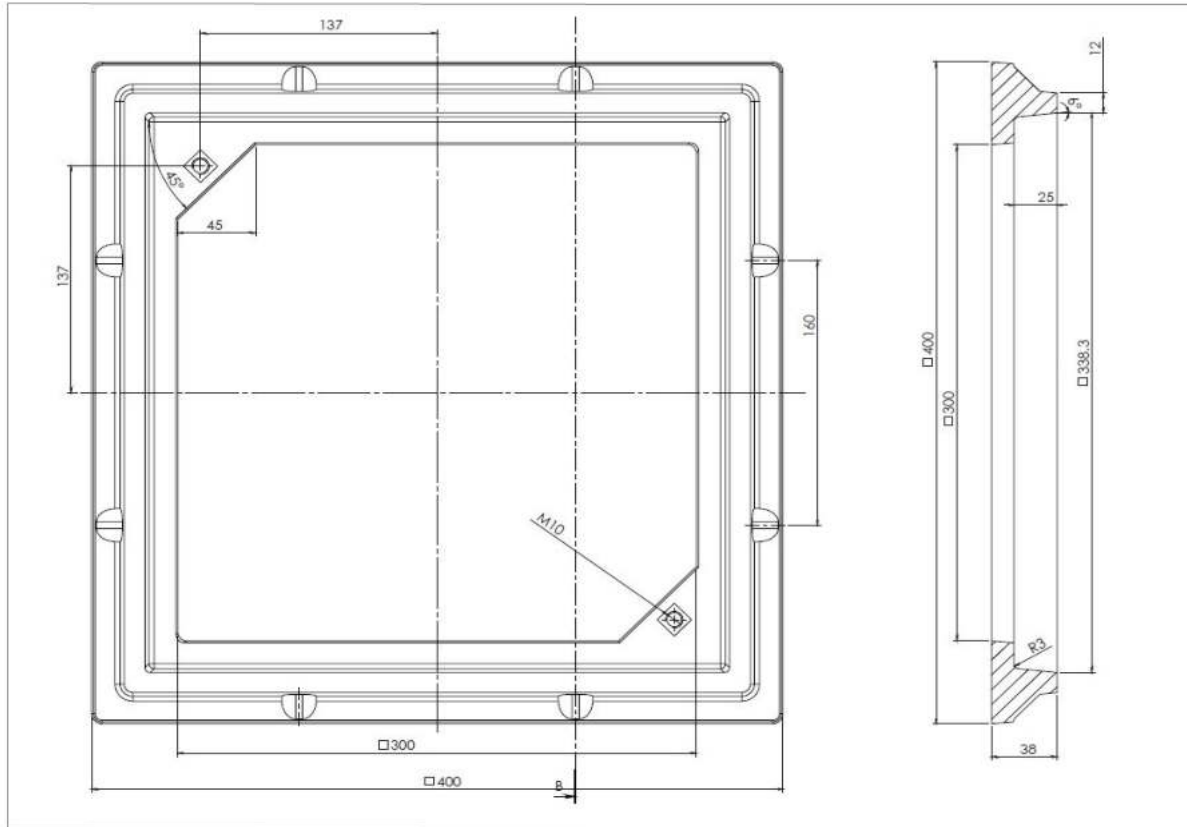

CABLE CHAMBER

600x600x800

From polymer composite

INCLUDES:

Cover & Frame – 1 pc

Walls – 4 pcs

Bottom – 1 pc



INTERNAL DIMENSIONS, MM

600x600x800



EXTERNAL DIMENSIONS OF COVER, MM

660x660x899

COVER LOADING CAPACITY

B 125

600x600x800

CABLE CHAMBER

From polymer composite
100% recycled materials

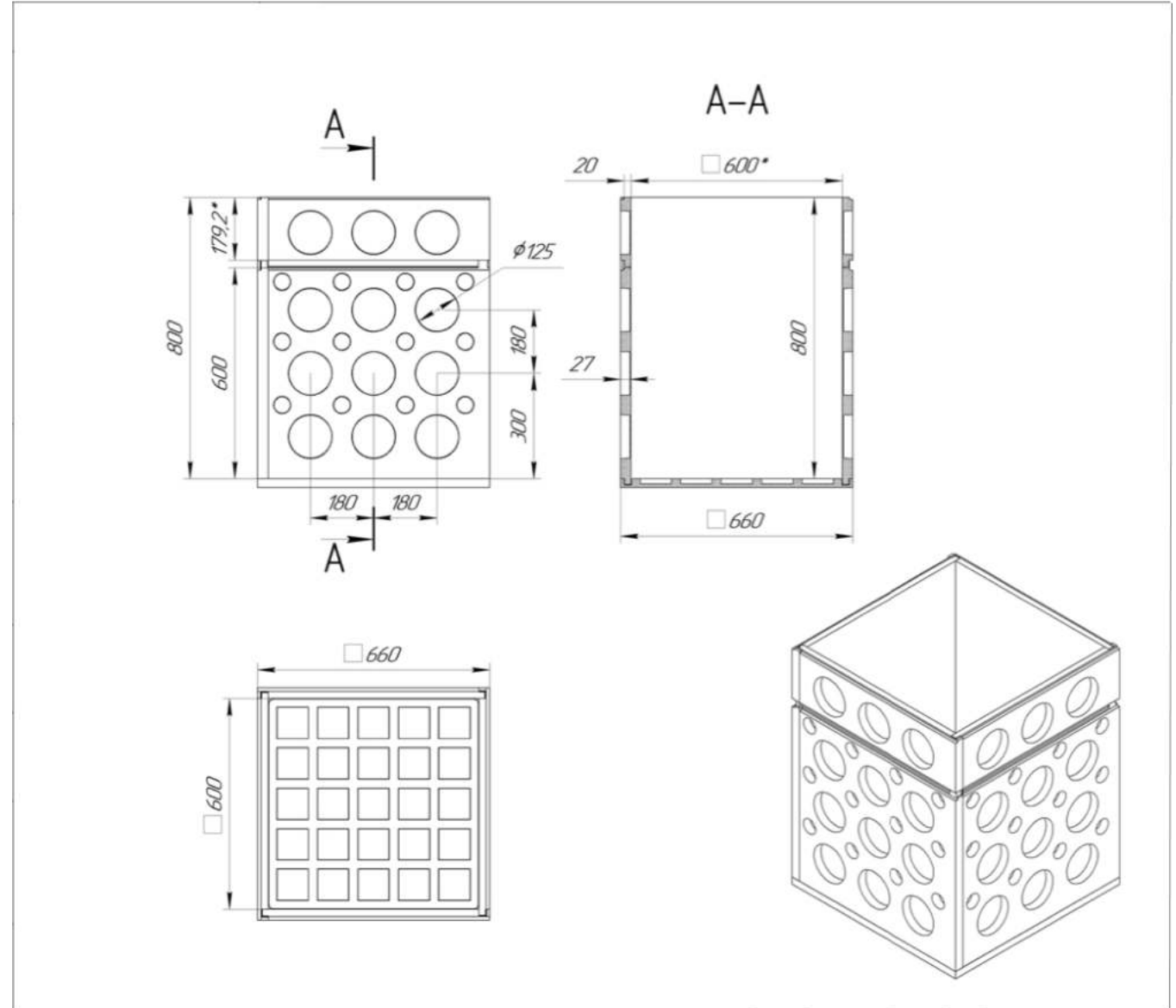
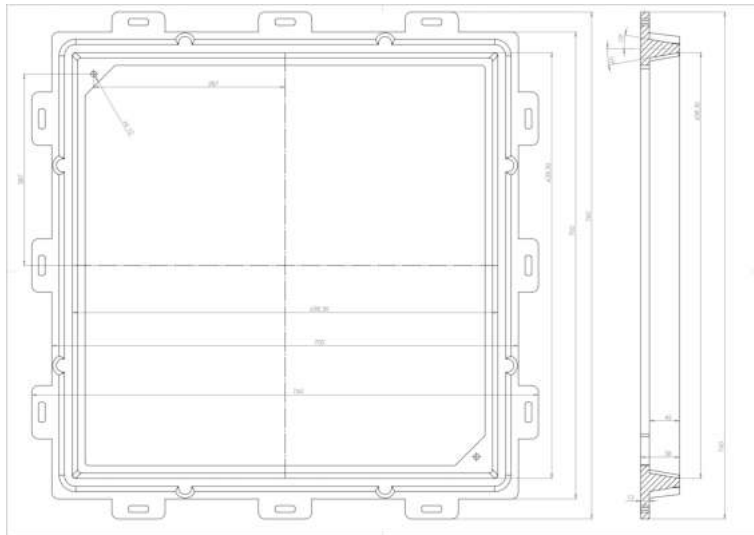
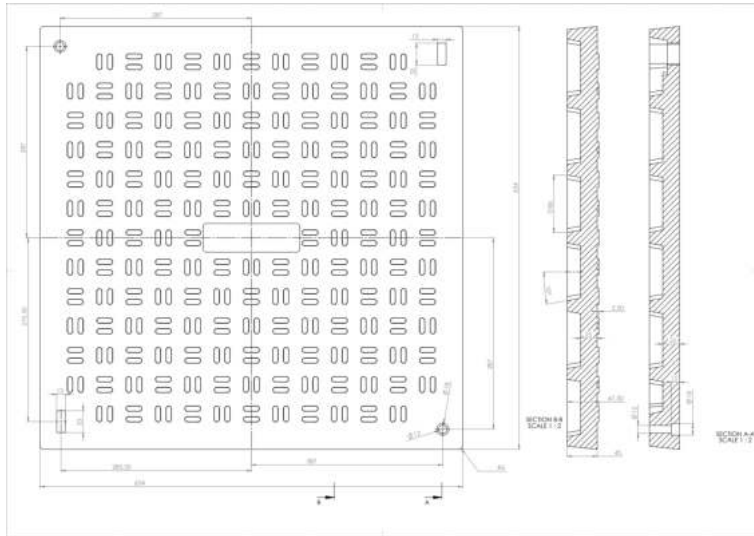

CABLE CHAMBER

800x800x800

From polymer composite
100% recycled materials

INCLUDES:

Cover & Frame – 1 pc

Walls – 4 pcs

Bottom – 1 pc



INTERNAL DIMENSIONS, MM

800x800x800

800x800x800

EXTERNAL DIMENSIONS OF COVER, MM

964x964

964x964

COVER LOADING CAPACITY

B 125

C 250

800x800x800

CABLE CHAMBER

From polymer composite
100% recycled materials

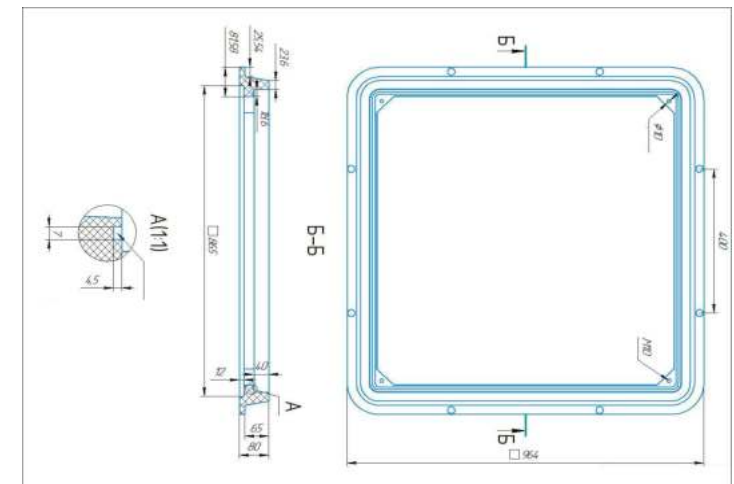
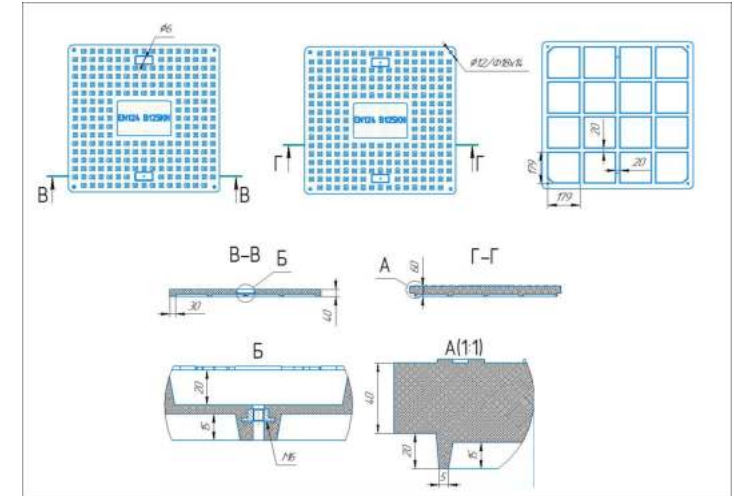
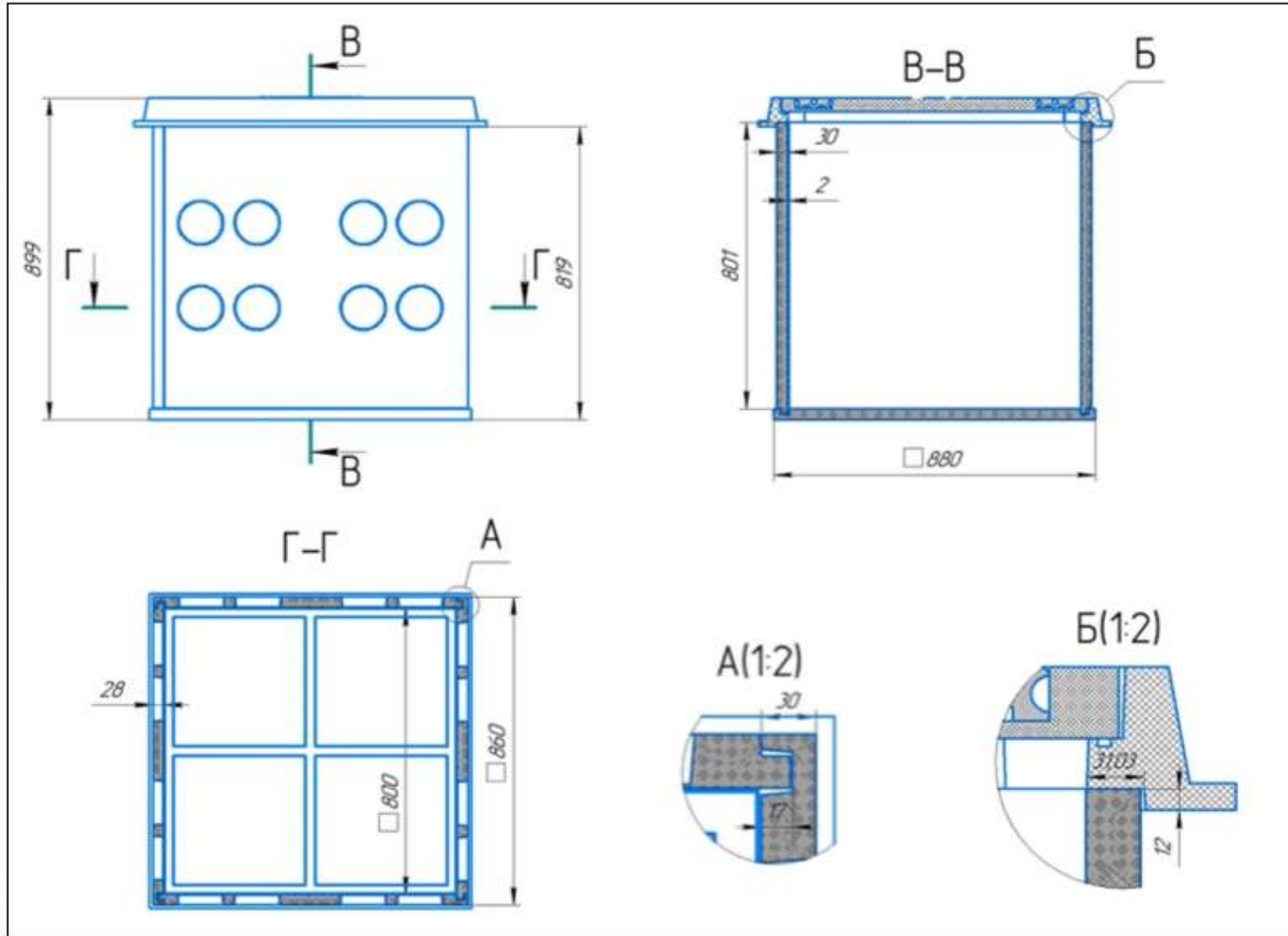

INSTRUCTION FOR SHAFT ASSEMBLING

STEP 1



STEP 2



STEP 3



READY TO USE

STEP 4



STEP 5



STEP 6



MANHOLE COVER

WITH RING

From polymer composite

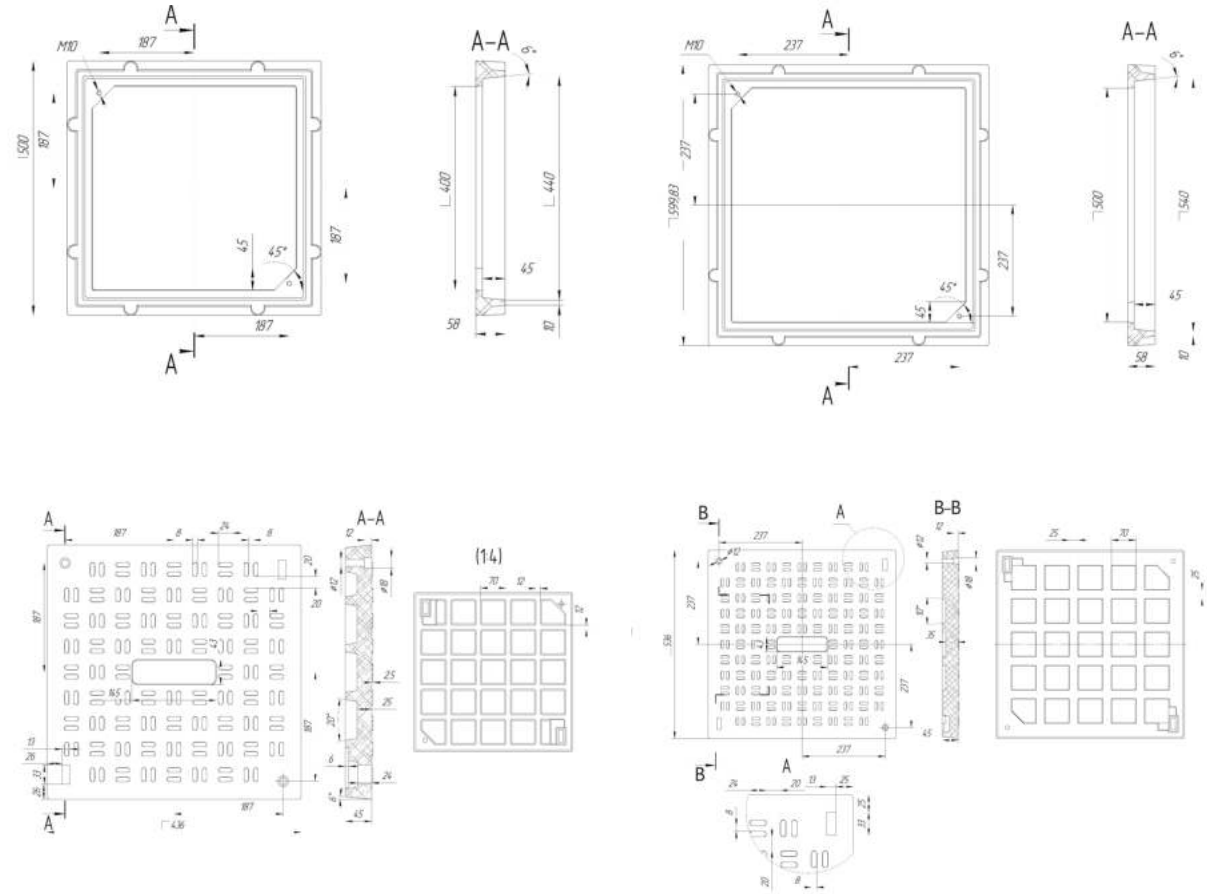

Product type according to standard EN124-5:	Cover with frame 12.5 t	Cover with frame 12.5 t
Load class:	B125	B125
Clear opening dimension:	400 mm / 400 mm	500 mm / 500 mm
External dimension:	500 mm / 500 mm	600 mm / 600 mm
Load capacity:	12.5 t	12.5 t
Weight:	11 kg	12 kg
Number of pieces per pallet:	40	30

MANHOLE COVER

WITH RING

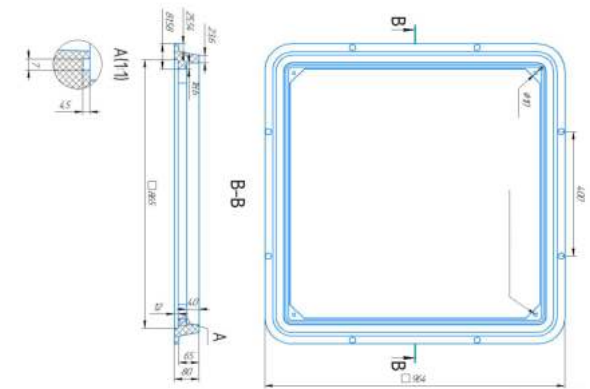
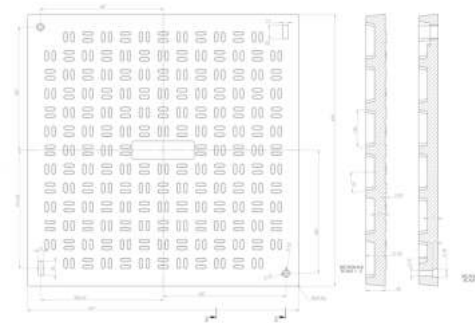
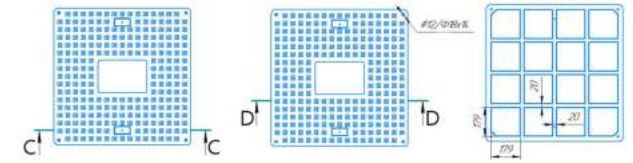
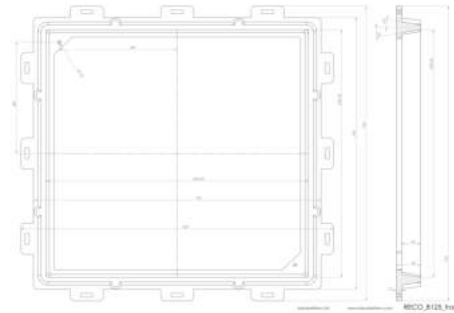

Product type according to standard EN124:

Cover with frame 12.5 t

Cover with frame 12.5 t

Load class:

B125

B125

Clear opening dimension:

600 mm / 600 mm

800 mm / 800 mm

External dimension:

770 mm / 770 mm

964 mm / 964 mm

Load capacity:

12.5 t

12.5 t

Weight:

24 kg

40 kg

Number of pieces per pallet:

20

15